

# ONYX-S

Ergonomic design with stylish body lines is the defining feature of this turnstile. The inclined scratch resistant glass top gives this turnstile a futuristic look making it a stylish architectural element to compliment any modern interior.

Onyx-S turnstiles are equipped with an automatic bidirectional servo-drive mechanism with a robust locking system and are able to operate reliably and efficiently in high traffic flow locations.

Onyx-S has a robust hub with stainless steel arms and a fully automatic anti-panic system, where in the case of an emergency, the arms are automatically lowered and users can freely pass through unhindered.



*COMBINE SLEEK, ERGONOMIC DESIGN WITH ROBUST ENGINEERING*



## Key features:

- Seamlessly Integrates with Various Access Control and ID Systems;
- Ergonomically Crafted with Stylish Lines;
- Servo-Driven Tripod Turnstile with Anti-Panic (Drop-Arm) Function;
- Automatic Reset for Anti-Panic Feature;
- Perfect Fusion of Affordability and High Quality;
- Low Power Consumption;
- Backup Battery Power Connection for Continuous Operation;
- Silent Operation Ensures User Comfort;
- Compatible with Ramped Base Mobile Platform (TiSO Frame-M);
- Extensive Array of Accessories for Customization;
- Wired Remote Control Included in Standard Kit;
- Clear Guidance with 4 LED Indicators
- Built-In Space for RFID Readers Under Top Glass;
- Turnstile Supplied Ready for Installation.

**Technical Specifications:**

Model	Onyx-S
Width, mm	825
Length, mm	790
Height, mm	1075
Passage width, mm	600
Mechanism	Servo-driven (Triservo-M)
Blocking system	Two electromagnetic stoppers
Emergency mode (fire-alarm)	Fail-safe (lowering the leash)
Drop arm function	Drop arm function can be activated when power is on Drop arm function activates automatically when power goes off
MCBF, cycles	5 000 000

**Electrical Specifications:**

Maximum power consumption, W	55
Voltage	From the AC (100-240)V, 50/60Hz; from a DC source 12 V

**Finishing**

Standard housing	Brushed SS AISI 304
Available housing	Brushed SS AISI 316; Polished SS AISI 304; Polished SS AISI 316; Powder coated RAL

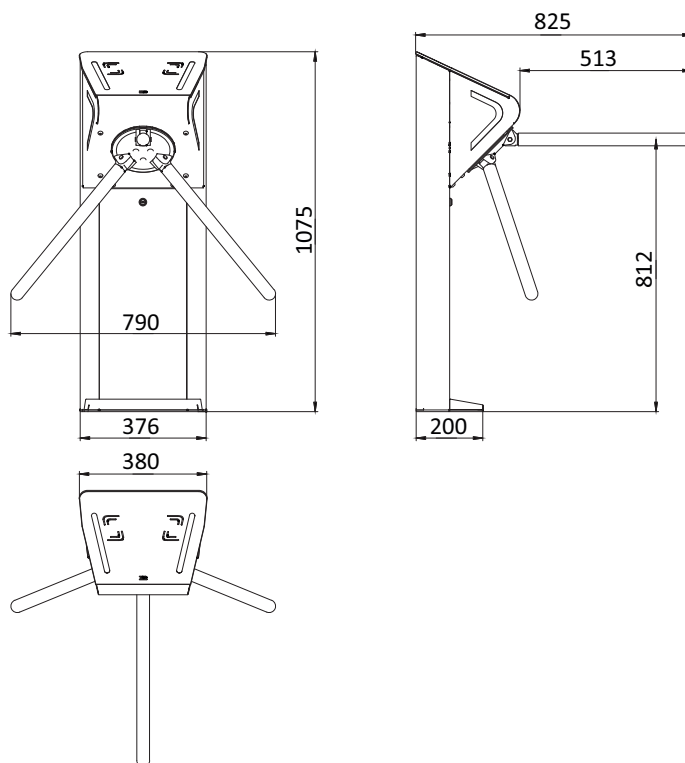

*Specifications are subject to change without prior notice.*

# STANDARD FEATURES

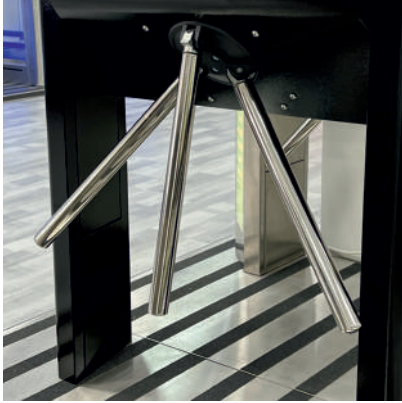

## DROP ARM/ ANTI-PANIC FUNCTION

In case of an emergency situation, the turnstile arm lowers automatically (with automatic reset). This function is basic and included as standard. In this way, people can leave the premises quickly and safely.

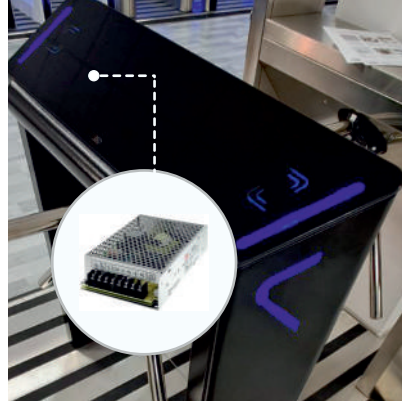

## POWER SUPPLY UNIT

Operates in a wide voltage range: 88 - 264 VAC (47 - 63 Hz). A reliable power supply unit is included to the standard set of the turnstile and guarantees reliable and maintenance-free operation of the turnstile in any country worldwide. Power supply unit without UPS function.



## UPS FUNCTION

A complex UPS system that automatically switches power to work from the back-up battery. This allows you to use all the functions of the turnstile in case of power fail.



## SIDE AND TOP LANE LIGHT INDICATORS

Bright and attention-grabbing RFIDLight® (LED light of card reader area) and two side dynamic as well as top RGB LED status displays.



## CONTROL PANEL

The wired control panel goes in a standard set. Allows to implement a single passage, a free passage, as well as blocks an access and activates the anti-panic function.

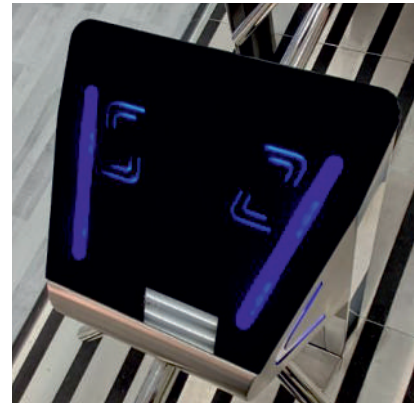

## PLACE FOR RFID INSTALLATION

Place for RFID installation is provided in the standard configuration of the tripod turnstile.

# OPTIONAL FEATURES



## INTEGRATION OF CUSTOMIZED ACS

Any access control systems up on request (e.g. RFID device, coin acceptor push button, fingerprint, face recognition, barcode and QRcode reader).

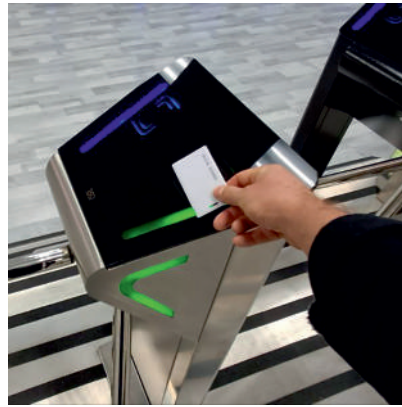

## RFID READERS T-PROX MINI

Reader operates with 125 kHz cards, Mifare, Mifare Plus and mobile credentials U-Prox ID over NFC and over 2.4 GHz radio.

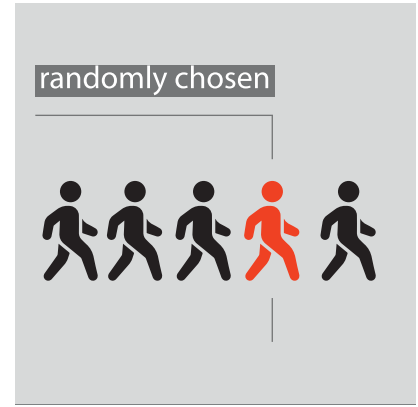

## RANDOMIZER

This mechanism automatically randomly selects a person for verification, without the influence of the human factor.



## MOBILE PLATFORM

Ensures quick temporary turnstile installation. As well as can be installed in areas where it is impossible to drill the floor.



## EXIT BUTTON

A convenient option that allows you to organize an exit by using a touch free button.



## COUNTER OF PASSAGES

Automatic counting of the number of passes.

# OPTIONAL FEATURES



## TWIC WIRELESS CONTROL PANEL

TiSO TWIC wireless control panel has space saving 10" touch screen display been specifically designed to be located at a reception desk or within security control areas.



## JUMPING OVER THE ARM + PASSAGE SIMULATION

Sensors detect jumping over the turnstile and simulation of passage. This allows you to prevent unauthorized entry to the premises.

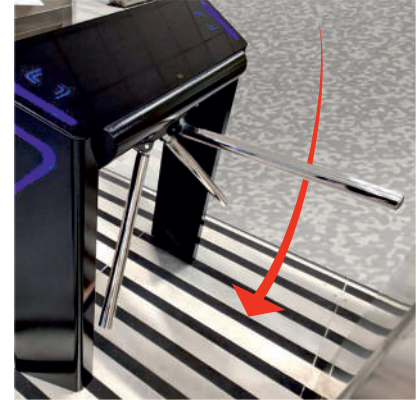

## CRAWLING UNDER THE ARM ALARM

Sensors detect crawling under the turnstile arm and activate an audio alarm to prevent unauthorized access to the area.